

- ① SFS FRAME
- ② CEMENT PARTICLE BOARD
- ③ INSULATION
- ④ ALUMINIUM NVELOPE BRACKETS
FIXED AT 600mm MAX
CENTRES VERTICALLY.
- ⑤ ALUMINIUM VERTICAL RAIL
NVELOPE NV7 PROFILE
- ⑥ NVELOPE FOAM TAPE
- ⑦ PANEL HOOKS
- ⑧ 3MM ALUMINIUM HOOK ON
PANELS

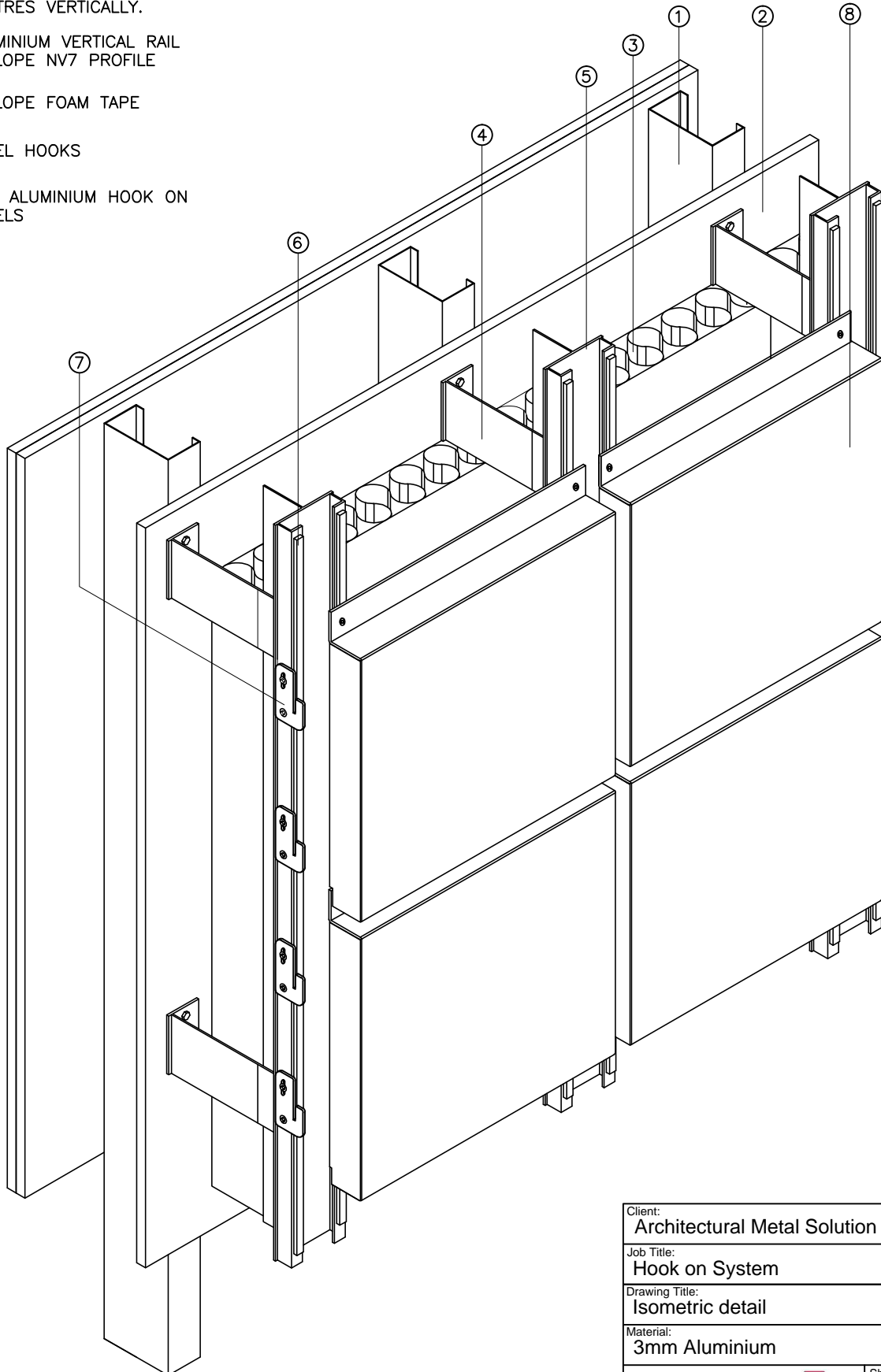

AMS-01 HOOK ON SYSTEM

Client: Architectural Metal Solution		Job No: -
Job Title: Hook on System		Date: 17/08/2018
Drawing Title: Isometric detail		Dwg. No.: AMS-01-01
Material: 3mm Aluminium		Finish: PPC
 CONCEPT TO CONSTRUCTION www.amsproducts.co.uk	Sheet Size: A4	Revision: -
	Scale: NTS	Drawn By: -
Tel: 01268 288661 Fax: 01268 287748		

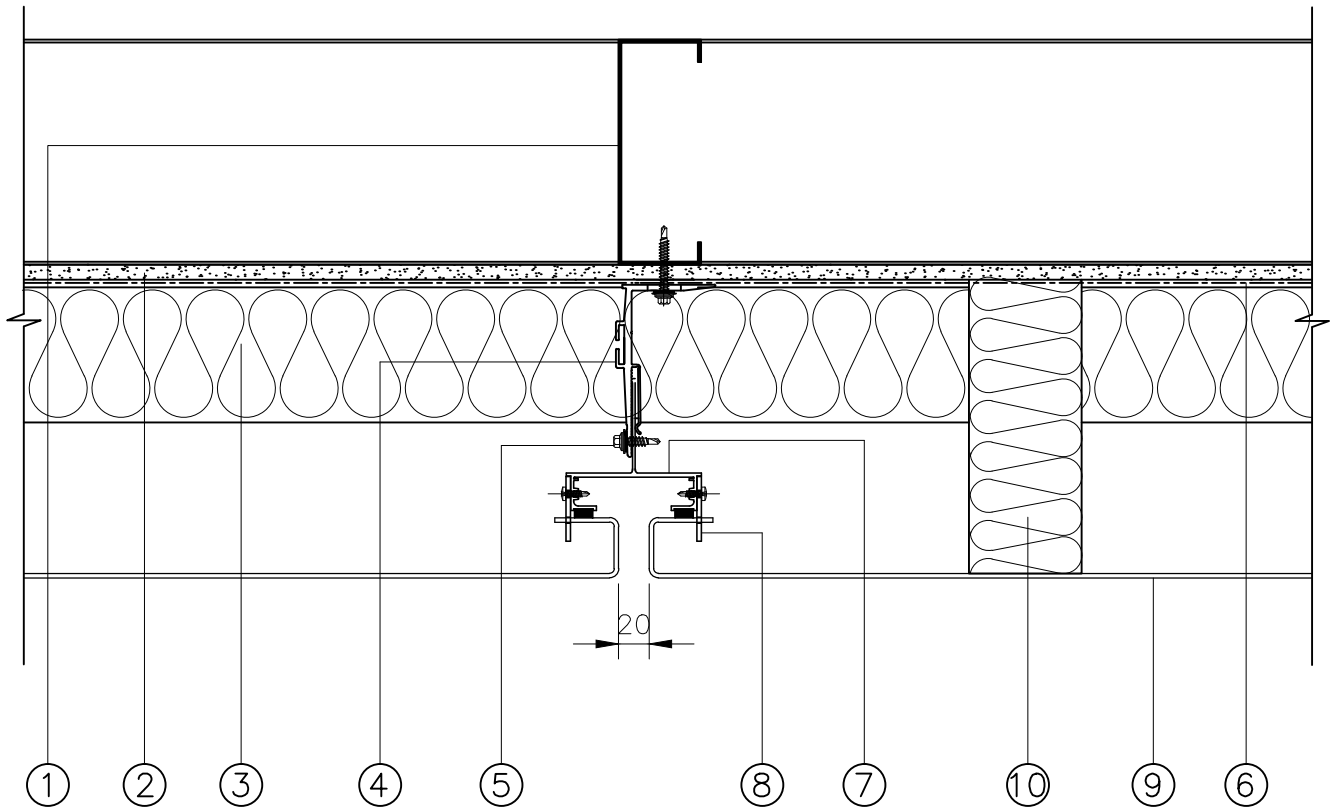

AMS-01 VERTICAL JOINT

- ① SFS FRAME
- ② CEMENT PARTICLE BOARD
- ③ INSULATION
- ④ ALUMINIUM NVELOPE BRACKETS
FIXED AT 600mm MAX
CENTRES VERTICALLY.
- ⑤ SELF DRILLING STAINLESS
STEEL SCREW
- ⑥ BREATHER MEMBRANE
- ⑦ ALUMINIUM VERTICAL RAIL
NVELOPE NV7 PROFILE
- ⑧ PANEL HOOKS
- ⑨ 3MM ALUMINIUM HOOK ON
PANELS
- ⑩ CAVITY BARRIER

AMS-01 HOOK ON SYSTEM

Client: Architectural Metal Solution	Job No: -	
Job Title: Hook on System	Date: 17/08/2018	
Drawing Title: AMS-01 Vertical Joint Detail	Dwg. No.: AMS-01-02	
Material: 3mm Aluminium	Finish: PPC	
 CONCEPT TO CONSTRUCTION www.amsproducts.co.uk	Sheet Size: A4	Revision: -
	Scale: NTS	Drawn By: -

Tel: 01268 288661
Fax: 01268 287748

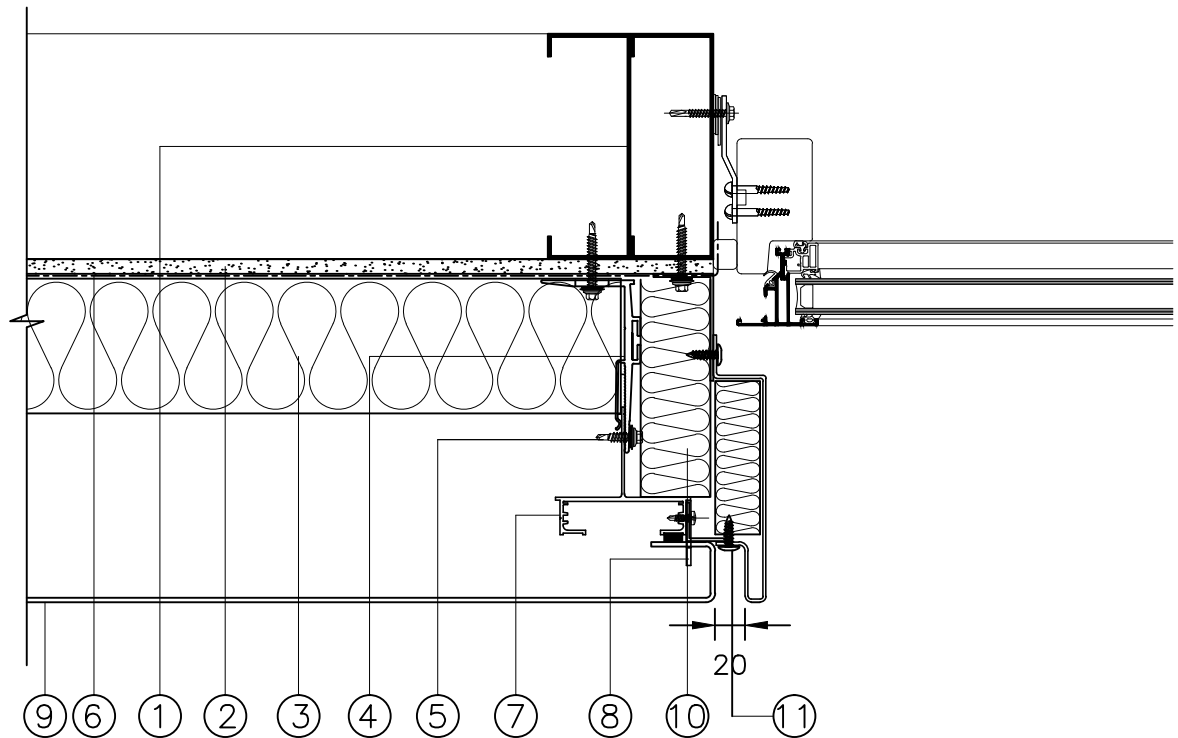

AMS-01 WINDOW JAMB DETAIL

- ① SFS FRAME
- ② CEMENT PARTICLE BOARD
- ③ INSULATION
- ④ ALUMINIUM NVELOPE BRACKETS
FIXED AT 600mm MAX
CENTRES VERTICALLY.
- ⑤ SELF DRILLING STAINLESS
STEEL SCREW
- ⑥ BREATHER MEMBRANE
- ⑦ ALUMINIUM VERTICAL RAIL
NVELOPE NV7 PROFILE
- ⑧ PANEL HOOKS
- ⑨ 3MM ALUMINIUM HOOK ON
PANELS
- ⑩ CAVITY BARRIER
- ⑪ COLOUR CODED STAINLESS
STEEL SCREW

AMS-01 HOOK ON SYSTEM

Client: Architectural Metal Solution		Job No: -
Job Title: Hook on System		Date: 17/08/2018
Drawing Title: AMS-01 Window Jamb Detail		Dwg. No.: AMS-01-03
Material: 3mm Aluminium		Finish: PPC
 CONCEPT TO CONSTRUCTION www.amsproducts.co.uk	Sheet Size: A4	Revision: -
	Scale: NTS	Drawn By: -
Tel: 01268 288661 Fax: 01268 287748		

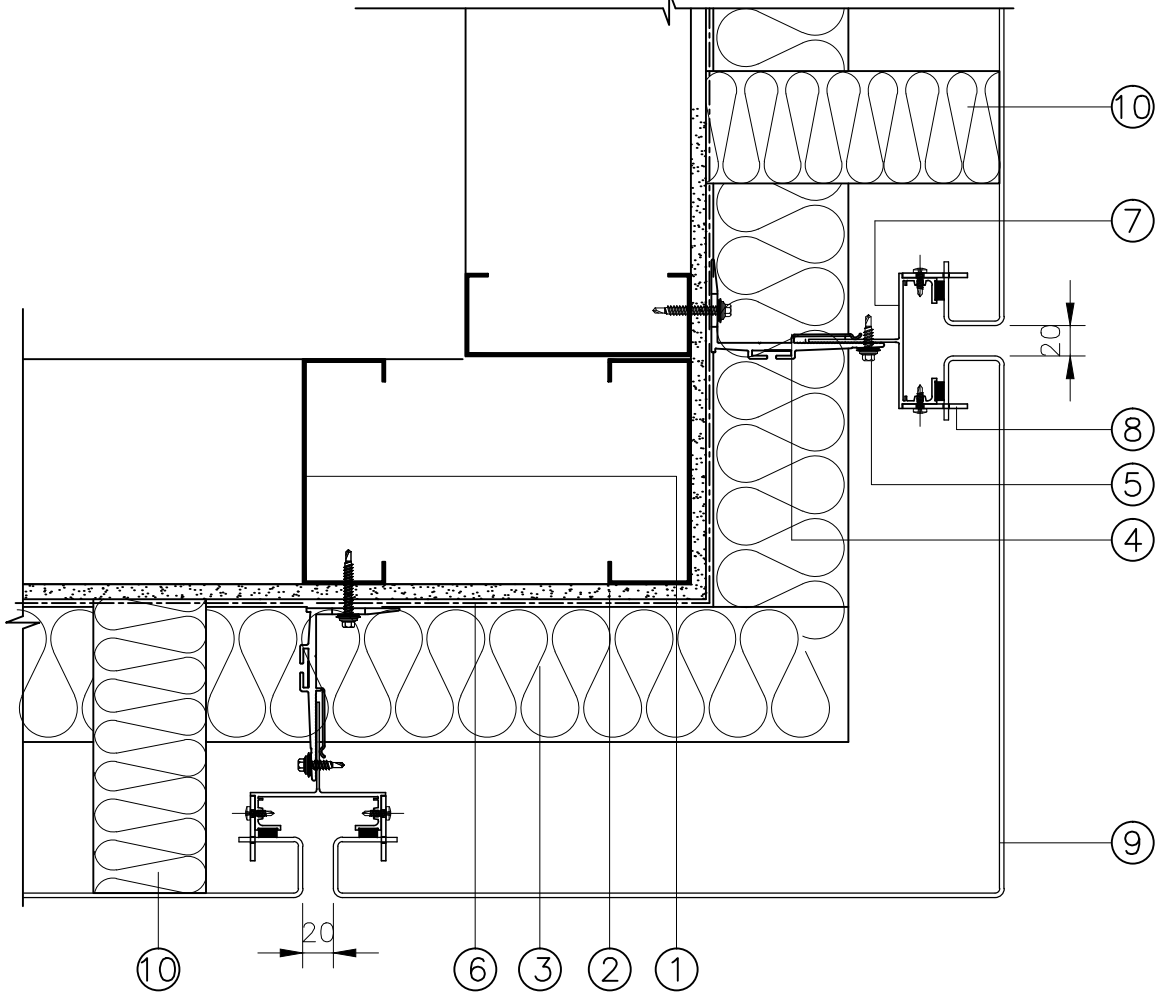

AMS-01 EXTERNAL CORNER DETAIL

- ① SFS FRAME
- ② CEMENT PARTICLE BOARD
- ③ INSULATION
- ④ ALUMINIUM NVELOPE BRACKETS
FIXED AT 600mm MAX
CENTRES VERTICALLY.
- ⑤ SELF DRILLING STAINLESS
STEEL SCREW
- ⑥ BREATHER MEMBRANE
- ⑦ ALUMINIUM VERTICAL RAIL
NVELOPE NV7 PROFILE
- ⑧ PANEL HOOKS
- ⑨ 3MM ALUMINIUM HOOK ON
PANELS
- ⑩ CAVITY BARRIER

AMS-01 HOOK ON SYSTEM

Client: Architectural Metal Solution	Job No: -	
Job Title: Hook on System	Date: 17/08/2018	
Drawing Title: AMS-01 External Corner	Dwg. No.: AMS-01-04	
Material: 3mm Aluminium	Finish: PPC	
 CONCEPT TO CONSTRUCTION www.amsproducts.co.uk	Sheet Size: A4	Revision: -
	Scale: NTS	Drawn By: -
	Tel: 01268 288661 Fax: 01268 287748	

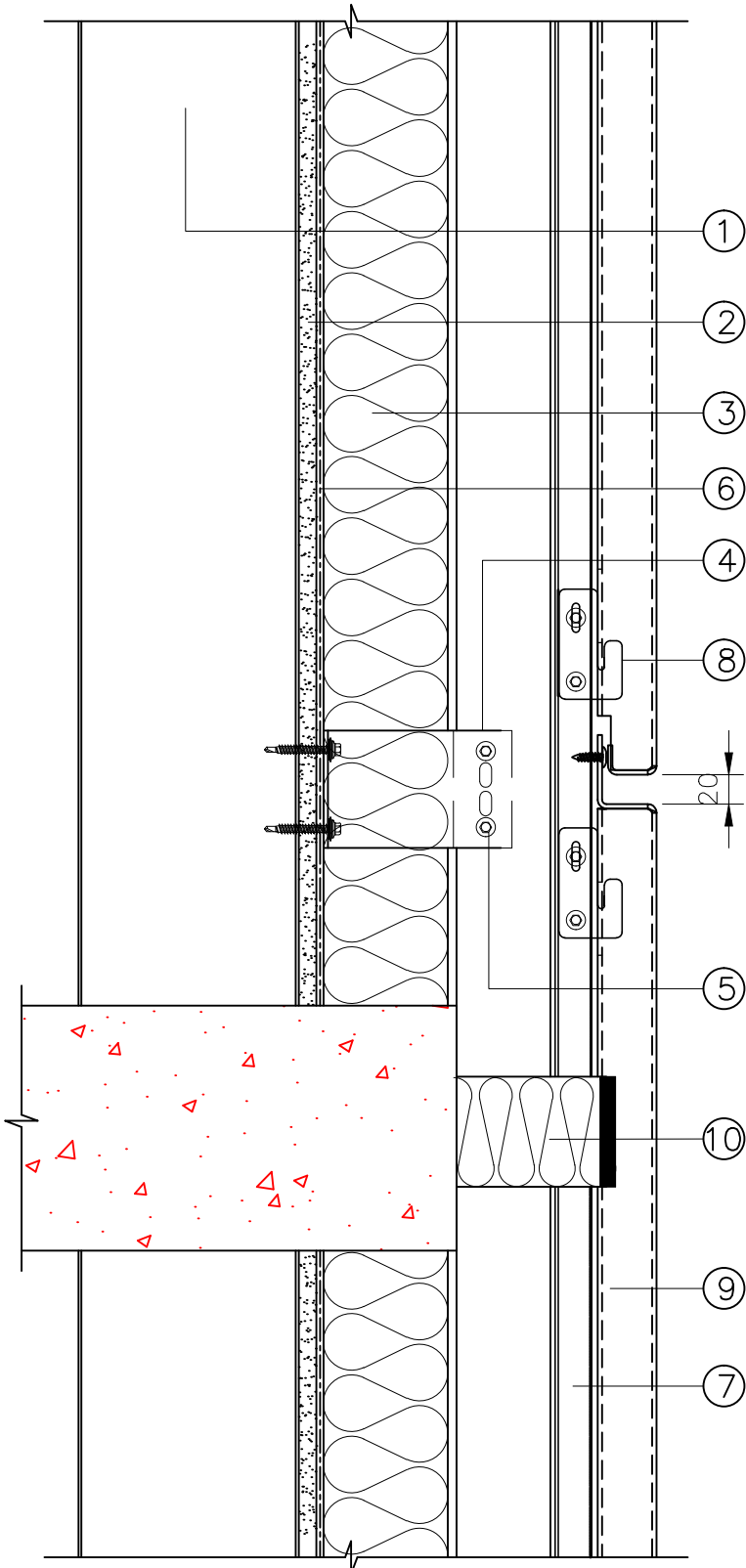

AMS-01 HORIZONTAL JOINT

- ① SFS FRAME
- ② CEMENT PARTICLE BOARD
- ③ INSULATION
- ④ ALUMINIUM NVELOPE BRACKETS
FIXED AT 600mm MAX
CENTRES VERTICALLY.
- ⑤ SELF DRILLING STAINLESS
STEEL SCREW
- ⑥ BREATHER MEMBRANE
- ⑦ ALUMINIUM VERTICAL RAIL
NVELOPE NV7 PROFILE
- ⑧ PANEL HOOKS
- ⑨ 3MM ALUMINIUM HOOK ON
PANELS
- ⑩ OPEN STATE CAVITY BARRIER

AMS-01 HOOK ON SYSTEM

Client: Architectural Metal Solution	Job No: -	
Job Title: Hook on System	Date: 17/08/2018	
Drawing Title: AMS-01 Horizontal Joint	Dwg. No.: AMS-01-05	
Material: 3mm Aluminium	Finish: PPC	
 CONCEPT TO CONSTRUCTION www.amsproducts.co.uk	Sheet Size: A4	Revision: -
	Scale: NTS	Drawn By: -
Tel: 01268 288661 Fax: 01268 287748		

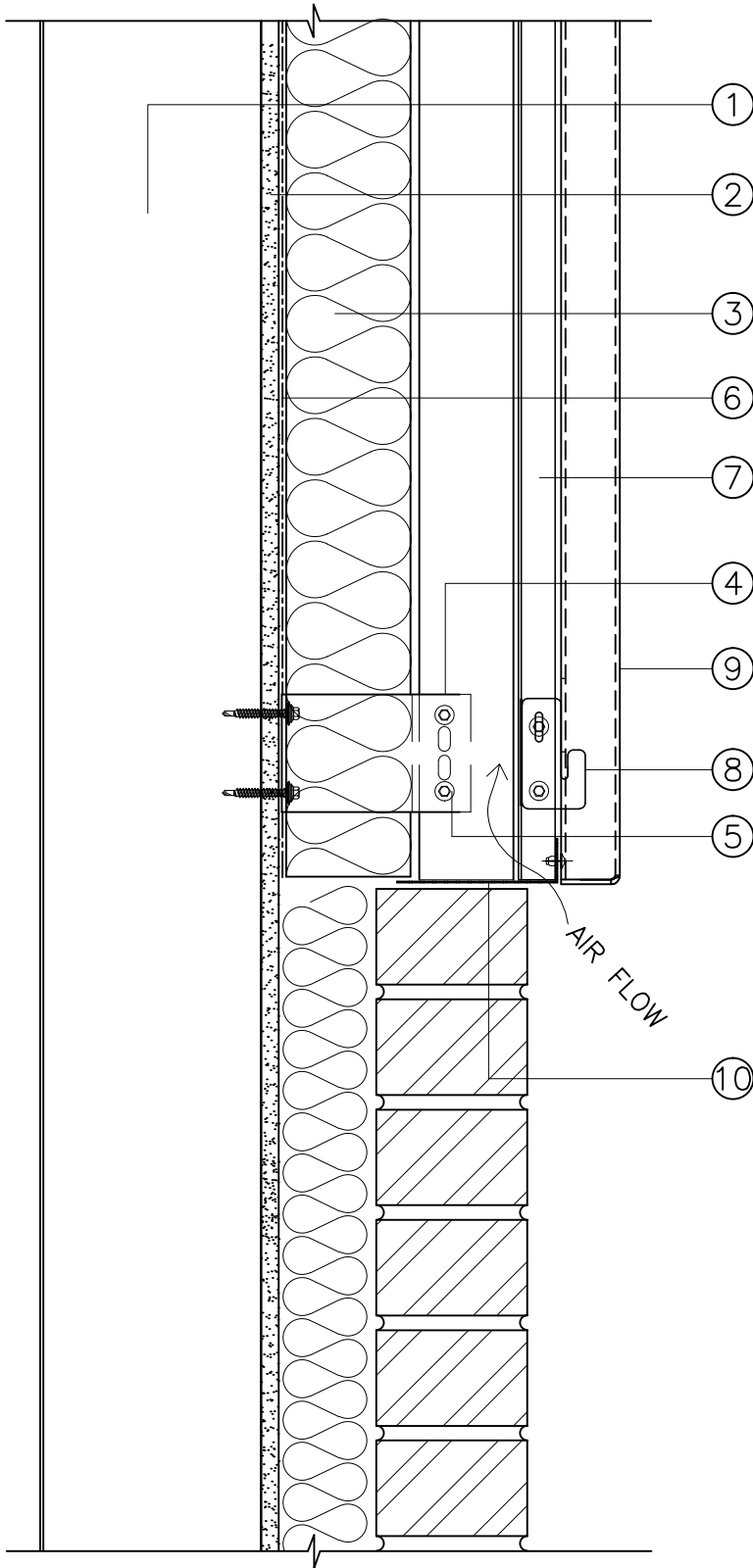

AMS-01 CILL DETAIL

- ① SFS FRAME
- ② CEMENT PARTICLE BOARD
- ③ INSULATION
- ④ ALUMINIUM NVELOPE BRACKETS
FIXED AT 600mm MAX
CENTRES VERTICALLY.
- ⑤ SELF DRILLING STAINLESS
STEEL SCREW
- ⑥ BREATHER MEMBRANE
- ⑦ ALUMINIUM VERTICAL RAIL
NVELOPE NV7 PROFILE
- ⑧ PANEL HOOKS
- ⑨ 3MM ALUMINIUM HOOK ON
PANELS
- ⑩ PERFORATED CLOSER

AMS-01 HOOK ON SYSTEM

Client: Architectural Metal Solution	Job No: -
Job Title: Hook on System	Date: 17/08/2018
Drawing Title: AMS-01 Cill Detail	Dwg. No.: AMS-01-06
Material: 3mm Aluminium	Finish: PPC
 <small>CONCEPT TO CONSTRUCTION www.amsproducts.co.uk</small>	Sheet Size: A4
	Scale: NTS
<small>Tel: 01268 288661 Fax: 01268 287748</small>	Revision: - Drawn By: -

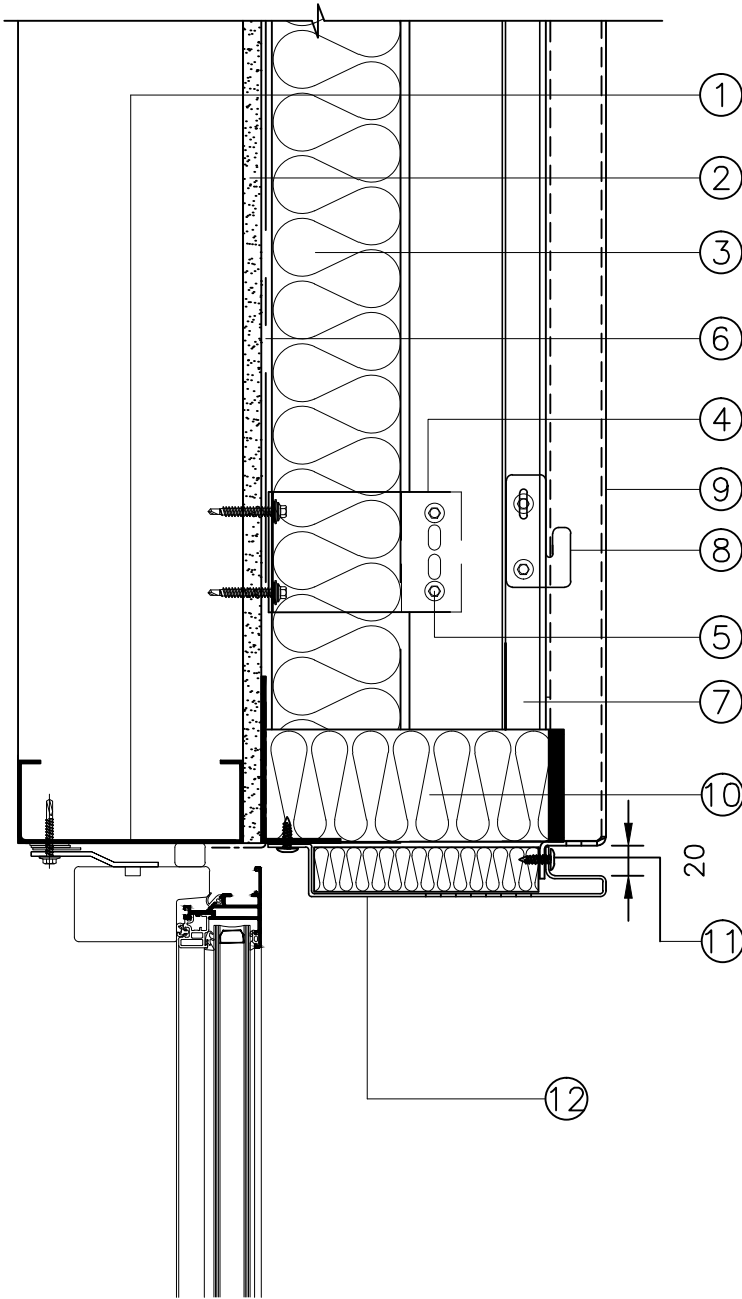

AMS-01 WINDOW HEAD DETAIL

- ① SFS FRAME
- ② CEMENT PARTICLE BOARD
- ③ INSULATION
- ④ ALUMINIUM NVELOPE BRACKETS
FIXED AT 600mm MAX
CENTRES VERTICALLY.
- ⑤ SELF DRILLING STAINLESS
STEEL SCREW
- ⑥ BREATHER MEMBRANE
- ⑦ ALUMINIUM VERTICAL RAIL
NVELOPE NV7 PROFILE
- ⑧ PANEL HOOKS
- ⑨ 3MM ALUMINIUM HOOK ON
PANELS
- ⑩ OPEN STATE CAVITY BARRIER
- ⑪ COLOUR CODED STAINLESS
STEEL SCREW
- ⑫ PERFORATED LINER

AMS-01 HOOK ON SYSTEM

Client: Architectural Metal Solution	Job No: -	
Job Title: Hook on System	Date: 17/08/2018	
Drawing Title: AMS-01 Window Head Detail	Dwg. No.: AMS-01-07	
Material: 3mm Aluminium	Finish: PPC	
 CONCEPT TO CONSTRUCTION www.amsproducts.co.uk	Sheet Size: A4	Revision: -
	Scale: NTS	Drawn By: -
Tel: 01268 28861 Fax: 01268 287748		

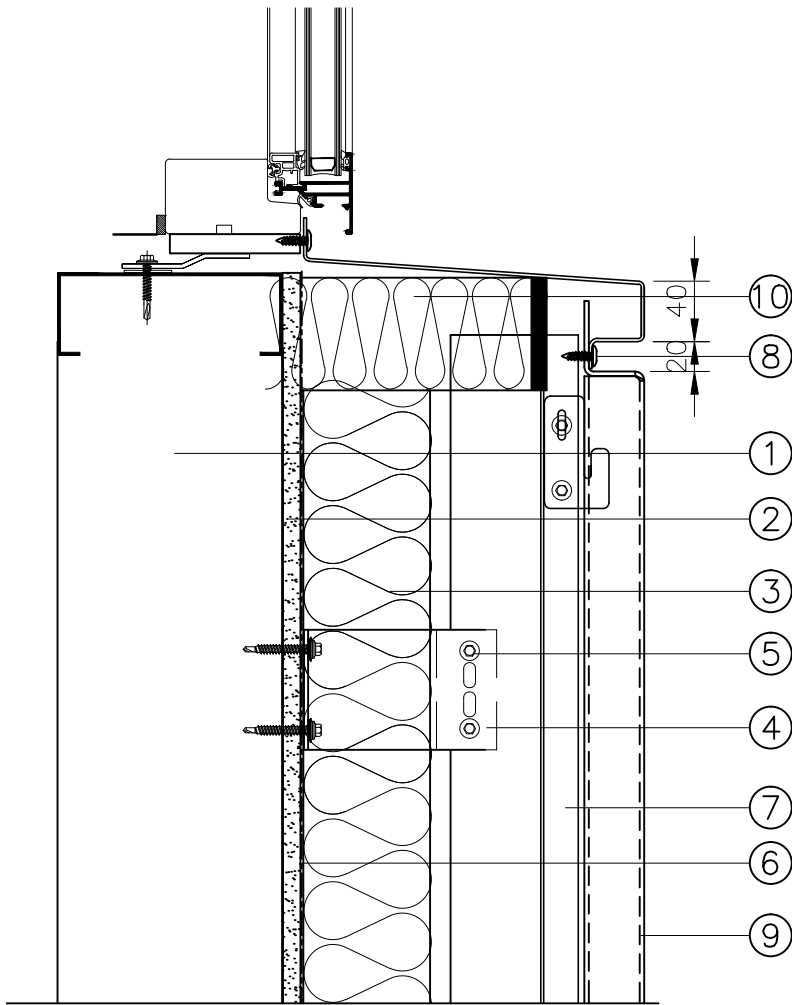

AMS-01 WINDOW SILL DETAIL

- ① SFS FRAME
- ② CEMENT PARTICLE BOARD
- ③ INSULATION
- ④ ALUMINIUM NVELOPE BRACKETS
FIXED AT 600mm MAX
CENTRES VERTICALLY.
- ⑤ SELF DRILLING STAINLESS
STEEL SCREW
- ⑥ BREATHER MEMBRANE
- ⑦ ALUMINIUM VERTICAL RAIL
NVELOPE NV7 PROFILE
- ⑧ COLOUR CODED STAINLESS
STEEL SCREW
- ⑨ 3MM ALUMINIUM HOOK ON
PANELS
- ⑩ OPEN STATE CAVITY BARRIER

AMS-01 HOOK ON SYSTEM

Client: Architectural Metal Solution		Job No: -
Job Title: Hook on System		Date: 17/08/2018
Drawing Title: AMS-01 Window Sill Detail		Dwg. No.: AMS-01-08
Material: 3mm Aluminium		Finish: PPC
 CONCEPT TO CONSTRUCTION www.amsproducts.co.uk	Sheet Size: A4	Revision: -
	Scale: NTS	Drawn By: -
Tel: 01268 288661 Fax: 01268 287748		